

CONTOUR Fluted Grabrails

Providing stability and confidence

The additional of a grabrail can offer the user the added reassurance and assistance they may need when using the shower area. Choose from a variety of affordable, durable and practical sizes, as well as colours to assist the visually impaired.

The BS8300:2001 recommendation for grabrail height from the floor in the design of buildings to meet the needs of disabled people are as follows: Diagonally (approx 15°) – Lowest end near the seat, 680mm from the floor.
Vertically: Between 800mm and 1300mm Horizontally: Between 1050mm and 1405mm

FLUTED GRABRAIL

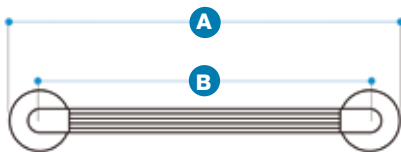

- Fluted detail offers the user a positive grip in and around the shower area.
- Variety of sizes to suit any shower area.
- Concealed wall fixings.
- Multiple holes for fixing to the wall, for a more secure installation.
- Made from strong 36mm diameter PVC tubing.
- Available in white, yellow and blue to assist the visually impaired.

Dimensions			Reference		
Length	A	B	White	Yellow	Blue
300mm	385	300	03F300W	03F300Y	03F300B
450mm	535	450	03F450W	03F450Y	03F450B
600mm	685	600	03F600W	03F600Y	03F600B

90° ANGLED FLUTED GRABRAIL

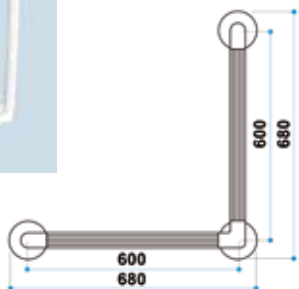

- Combines the convenience of a horizontal and vertical grabrail for an assured grip.
- Fluted detail offers the user a positive grip in and around the shower area.
- Available in White, Yellow or Blue to assist the visually impaired.
- Made from strong 36mm diameter PVC tubing.

	White	Yellow	Blue
Reference	03FA90W	03FA90Y	03FA90B

135° ANGLED FLUTED GRABRAIL

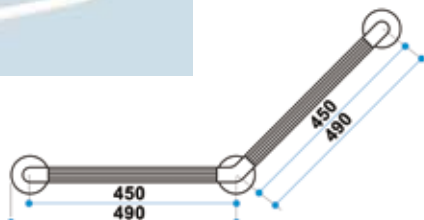

- Angled grabrail allows people with a weaker grip to use their forearm for extra leverage.
- Fluted detail offers the user a positive grip in and around the shower area.
- Available in White, Yellow or Blue to assist the visually impaired.
- Made from strong 36mm diameter PVC tubing.

	White	Yellow	Blue
Reference	03FA135W	03FA135Y	03FA135B

600x400 90° ANGLED FLUTED GRABRAIL

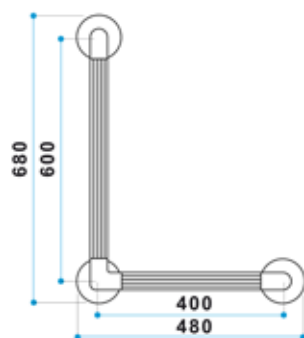

- Combines the convenience of a horizontal and vertical grabrail for an assured grip
- Fluted detail offers the user a positive grip in and around the shower area
- Available in White, Yellow or Blue to assist the visually impaired
- Made from strong 36mm diameter PVC tubing
- Left or right hand available

	White	Yellow	Blue
LH Reference	03FA6040LHW	03FA6040LHY	03FA6040LHB
RH Reference	03FA6040RHW	03FA6040RHY	03FA6040RHB

LUXE GRABRAIL

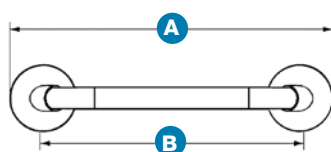

- Fluted detail offers the user a positive grip in and around the shower area
- Variety of sizes to suit any shower area
- Concealed wall fixing
- Combining a modern, sleek, polished finish

	Dimensions		Reference
Size	A	B	
300mm	390	305	03LUX300
450mm	545	455	03LUX450
600mm	700	610	03LUX600

HINGED ARM SUPPORT

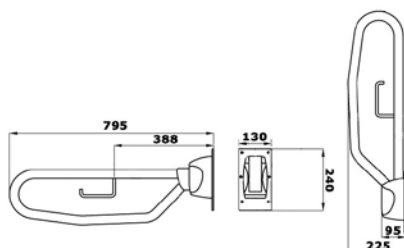

- Mounted by the side of a WC, shower or wash basin providing a safe way of sitting down and standing up or for making a transfer.
- Arm locks automatically in the upright position.
- Made from 35mm diameter, epoxy coated steel tubing.
- Integrated toilet roll holder.
- Available in white as standard and yellow and blue also to assist the visually impaired.
- Will withstand weights of upto **127kg, 20 stones.**

	White	Yellow	Blue
Reference	03HAW	03HAY	03HAB

HINGED ARM SUPPORT WITH LEG

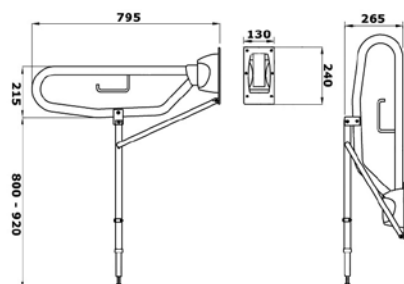

- Identical to the above Hinged Arm Support but integrates a support leg.
- Leg provides additional support and strength.
- Leg is adjustable in height, upto 120mm.
- Adjustable foot with anti-slip pad for final height adjustment.
- Available in white as standard and yellow and blue also to assist the visually impaired.
- Will withstand weights of upto **228kg, 36 stones.**

	White	Yellow	Blue
Reference	03HALW	03HALY	03HALB

Fluted Grabrails

- Fluted grabrails for a positive grip
- Hinged arm supports can be located next to a WC, shower or wash basin
- Colours available to assist the visually impaired