

# CONTOUR ShowerDec®

## Create a wet floor area

Quick and simple to install, our range of ShowerDec® floor formers enable bathrooms to be used as complete, level access wet floor areas. Creating falls in the floor of a traditional wet floor area is difficult and time consuming. Using the ShowerDec® floor former avoids that inconvenience and those additional labour costs, providing a perfect and trouble free level access showering area.







Practical for wooden and solid floor situations, and only 22mm thick, ShowerDec® is concealed underneath the vinyl floor covering once installed, guaranteeing the bathroom to be used as a complete, wheelchair friendly, wet floor environment without looking clinical.

## Pre-formed

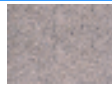
The pre-formed gradient incorporated into the top surface of ShowerDec® removes the necessity of having to create your own falls within the floor. All enclosures feature trimmable corner blocks and rise and fall hinges for effortless door opening.

- Only 22mm thick, easily locates in wooden or solid floor environments
- Level access guarantees wheeledchair entry
- Pre-formed gradient 1:40 to the drainage position
- No need to create difficult falls
- Cost effective, reduces valuable labour and disruption time
- Quick and simple to install, easily achieves cost savings compared with tiled or solid surfaces
- Trimmable by upto 30mm. If trimming by 30mm for example, it would be necessary to take 15mm off either side.
- No modifying of joists required
- 25 year guarantee
- Can be used with mosaic tiles if preferred. A gully adaptor is required when using mosaics, see page 97 for details. Tilesafe tanking membrane would also be needed, see page 105
- Light in weight whilst combining exceptional strength
- Flat formed bottom surface to assist with installation
- Supplied with Flexcon 2 & Flexcon 6, flexible connectors to assist with installation
- Enclosures integrate a corner block to overcome floor coving and rise and fall hinges for effortless door opening
- ShowerDec®s are not handed



	Suitable for wooden floors
	Suitable for screeded floors
	Below ground tray
	Yes
	Suitable for gravity waste
	Suitable for pumped waste
	Flexcon 2 supplied for assisted installation
	Flexcon 6 supplied to assist with angled or offset fitting



## SHOWERDEC – Standard Door Options

### CSD1300x800

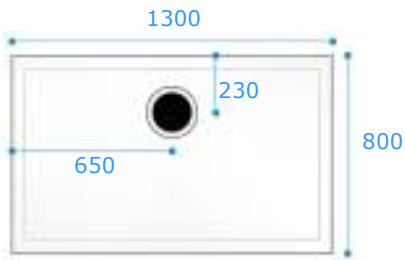

Not handed  
Reference Code: CSD1300x800

#### Option WF1



Bi-folding and single door provide maximum access.  
*Left hand illustrated*  
CSD1300x800WF1LH  
CSD1300x800WF1RH

#### Option WF3



Twin bi-folding doors provide access in a confined space.  
*Left hand illustrated*  
CSD1300x800WF3LH  
CSD1300x800WF3RH

#### Option WF6



Bi-folding door hinging from a fixed panel for corner access.  
*Left hand illustrated*  
CSD1300x800WF6LH  
CSD1300x800WF6RH

### CSD1000x1000

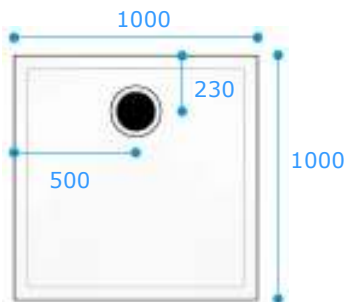

Not handed  
Reference Code: CSD1000x1000

#### Option WF1



Bi-folding and single door provide maximum access.  
*Left hand illustrated*  
CSD1000x1000WF1LH  
CSD1000x1000WF1RH

#### Option WF2



Bi-parting doors provide maximum access.  
*Not handed*  
CSD1000x1000WF2

#### Option WF3



Twin bi-folding doors provide access in a confined space.  
*Not handed*  
CSD1000x1000WF3

### CSD1500x800

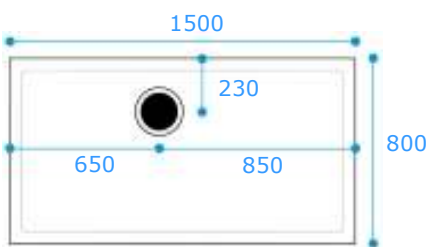

Not handed  
Reference Code: CSD1500x800

#### Option WF1



Bi-folding and single door provide maximum access.  
*Left hand illustrated*  
CSD1500x800WF1LH  
CSD1500x800WF1RH

#### Option WF3



Twin bi-folding doors provide access in a confined space.  
*Left hand illustrated*  
CSD1500x800WF3LH  
CSD1500x800WF3RH

#### Option WF6



Bi-folding door hinging from a fixed panel for corner access.  
*Left hand illustrated*  
CSD1500x800WF6LH  
CSD1500x800WF6RH

### CSD910x910

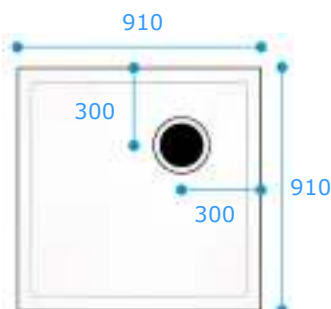

Not handed  
Reference Code: CSD910x910

#### Option WF1



Bi-folding and single door provide maximum access.  
*Left hand illustrated*  
CSD910x910WF1LH  
CSD910x910WF1RH

#### Option WF2



Bi-parting doors provide maximum access.  
*Not handed illustrated*  
CSD910x910WF2

#### Option WF3



Twin bi-folding doors provide access in a confined space.  
*Not handed illustrated*  
CSD910x910WF3

**Option WF20**



Sliding door can extend across the shower area and opens outwards. *Left hand illustrated*  
 CSD1300x800WF20LH  
 CSD1300x800WF20RH

**Option WF25**



Bi-folding door hinging from the fixed panel, allows easy access. *Left hand illustrated*  
 CSD1300x800WF25LH  
 CSD1300x800WF25RH

**Option WF28**



Single door hinging outwards with fixed front and return panels. *Left hand illustrated*  
 CSD1300x800WF28LH  
 CSD1300x800WF28RH

**Option WF32**



Twin bi-folding doors open to allow full access, with a return panel. *Left hand illustrated*  
 CSD1300x800WF32LH  
 CSD1300x800WF32RH

**Option WF5**



Twin sliding doors hinging from the wall allow maximum access. *Not handed*  
 CSD1000x1000WF5

**Option WF6**



Bi-folding door hinging from a fixed panel for corner access. *Left hand illustrated*  
 CSD1000x1000WF6LH  
 CSD1000x1000WF6RH

**Option WF20**



Sliding door can extend across the shower area and opens outwards. *Left hand illustrated*  
 CSD1000x1000WF20LH  
 CSD1000x1000WF20RH

**Option WF28**



Single door hinging outwards with fixed front and return panels. *Left hand illustrated*  
 CSD1000x1000WF28LH  
 CSD1000x1000WF28RH

**Option WF25**



Bi-folding door hinging from the fixed panel, allows easy access. *Left hand illustrated*  
 CSD1500x800WF25LH  
 CSD1500x800WF25RH

**Option WF28**



Single door hinging outwards with fixed front and return panels. *Left hand illustrated*  
 CSD1500x800WF28LH  
 CSD1500x800WF28RH

**Option WF32**



Twin bi-folding doors open to allow full access, with a return panel. *Left hand illustrated*  
 CSD1500x800WF32LH  
 CSD1500x800WF32RH

**Option WF34**



Bi-parting doors hinging from the fixed and return panel. *Left hand illustrated*  
 CSD1500x800WF34LH  
 CSD1500x800WF34RH

**Option WF5**



Twin sliding doors hinging from the wall allow maximum access. *Not handed*  
 CSD910x910WF5

**Option WF6**



Bi-folding door hinging from a fixed panel for corner access. *Left hand illustrated*  
 CSD910x910WF6LH  
 CSD910x910WF6RH

**Option WF20**



Sliding door can extend across the shower area and opens outwards. *Left hand illustrated*  
 CSD910x910WF20LH  
 CSD910x910WF20RH

**Option WF28**



Single door hinging outwards with fixed front and return panels. *Left hand illustrated*  
 CSD910x910WF28LH  
 CSD910x910WF28RH

[More Options >>>>](#)

**ShowerDec®**

- Create a level access wet floor area
- Only 22mm thick
- Quick & simple to install
- Not handed

## SHOWERDEC – Standard Door Options

### CSD810x810

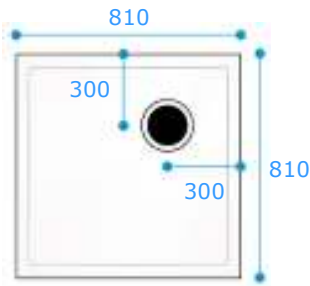

*Not handed*  
Reference Code: CSD810x810

#### Option WF1



Bi-folding and single door provide maximum access.  
*Left hand illustrated*  
CSD810x810WF1LH  
CSD810x810WF1RH

#### Option WF2



Bi-parting doors provide maximum access.  
*Not handed*  
CSD810x810WF2

#### Option WF3



Twin bi-folding doors provide access in a confined space.  
*Not handed*  
CSD810x810WF3

### CSD1400x900

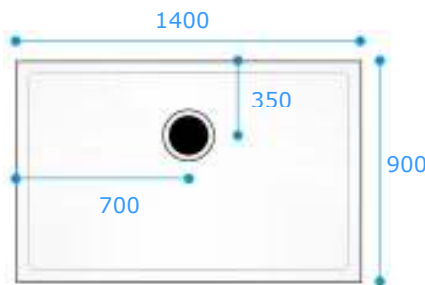

*Not handed*  
Reference Code: CSD1400x900

#### Option WF1



Bi-folding and single door provide maximum access.  
*Left hand illustrated*  
CSD1400x900WF1LH  
CSD1400x900WF1RH

#### Option WF3



Twin bi-folding doors provide access in a confined space.  
*Left hand illustrated*  
CSD1400x900WF3LH  
CSD1400x900WF3RH

#### Option WF6



Bi-folding door hinging from a fixed panel for corner access. *Left hand illustrated*  
CSD1400x900WF6LH  
CSD1400x900WF6RH

### CSD1200x1200

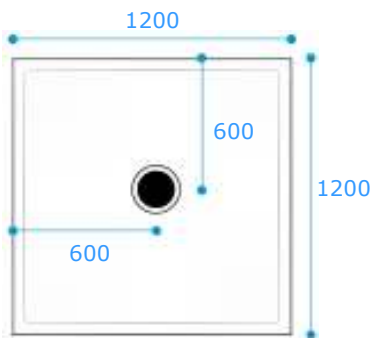

*Not handed*  
Reference Code: CSD1200x1200

#### Option WF1



Bi-folding and single door provide maximum access.  
*Left hand illustrated*  
CSD1200x1200WF1LH  
CSD1200x1200WF1RH

#### Option WF3



Twin bi-folding doors provide access in a confined space.  
*Not handed*  
CSD1200x1200WF3

#### Option WF5



Twin sliding doors hinging from the wall allow maximum access.  
*Not handed*  
CSD1200x1200WF5



Contour Coving is a pre-formed profile that produces the curved floor detail within a wet floor area, see page 100.

Tilesafe is a waterproof membrane that should be used beneath ceramic tiles in a wet room, see page 103.



**Option WF6**



Bi-folding door hinging from a fixed panel for corner access. *Left hand illustrated*  
CSD810x810WF6

**Option WF20**



Sliding door can extend across the shower area and opens outwards. *Left hand illustrated*  
CSD1400x900WF20LH  
CSD1400x900WF20RH

**Option WF25**



Bi-folding door hinging from the fixed panel, allows easy access. *Left hand illustrated*  
CSD1400x900WF25LH  
CSD1400x900WF25RH

**Option WF28**



Single door hinging outwards with fixed front and return panels. *Left hand illustrated*  
CSD1400x900WF28LH  
CSD1400x900WF28RH

**Option WF32**



Twin bi-folding doors open to allow full access, with a return panel. *Left hand illustrated*  
CSD1400x900WF32LH  
CSD1400x900WF32RH

**Option WF6**



Bi-folding door hinging from a fixed panel for corner access. *Left hand illustrated*  
CSD1200x1200WF6LH  
CSD1200x1200WF6RH

**Option WF20**



Sliding door can extend across the shower area and opens outwards. *Left hand illustrated*  
CSD1200x1200WF20LH  
CSD1200x1200WF20RH

**Option WF25**



Bi-folding door hinging from the fixed panel, allows easy access. *Left hand illustrated*  
CSD1200x1200WF25LH  
CSD1200x1200WF25RH

**Option WF28**



Single door hinging outwards with fixed front and return panels. *Left hand illustrated*  
CSD1200x1200WF28LH  
CSD1200x1200WF28RH

**ShowerDec®**

- Create a level access wet floor area
- Only 22mm thick
- Quick & simple to install
- Not handed